

Voltage Regulators

Features

- The output voltage can be adjusted to 36V
- Low dynamic output impedance, its typical value is 0.2 Ω Trapping current capability is 1 to 100mA
- The typical value of the equivalent temperature factor in the whole temperature scope is 50 ppm/
- The effective temperature compensation in the working range of full temperature
- Low output noise voltage
- Fast on-state response

MECHANICAL DATA

- Case: SOT-89 Small Outline Plastic Package
- Polarity: Color band denotes cathode end
- Mounting Position: Any

VOLTAGE : 37V
POWER DISSIPATION:500mW

SOT-89

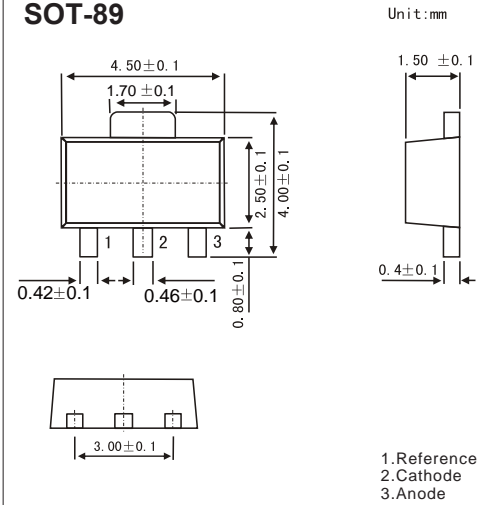

MAXIMUM RATINGS AND CHARACTERISTICS

@ 25°C Ambient Temperature (unless otherwise noted)

Parameter	Symbol	Value	Unit
Cathode Voltage	V_{KA}	37	V
Cathode Current Range (Continuous)	I_{KA}	-100~+150	mA
Reference Input Current Range	I_{ref}	0.05~+10	mA
Power Dissipation	P_D	500	mW
Thermal Resistance from Junction to Ambient	$R_{\theta JA}$	250	$^{\circ}C/W$
Operating Ambient Temperature Range	T_{opr}	0 ~ +70	$^{\circ}C$
Storage temperature Range	T_{stg}	-65~+150	$^{\circ}C$
Operating Junction Temperature	T_j	150	$^{\circ}C$

Electrical Specification ($T_A=25^{\circ}C$ unless otherwise specified)

Parameter	Symbol	Test conditions	Min	Typ	Max	Unit
Reference input voltage	V_{ref}	$V_{KA}=V_{REF}, I_{KA}=10mA$	2.450	2.5	2.550	V
Deviation of reference Input voltage over temperature (note)	$\Delta V_{ref}/\Delta T$	$V_{KA}=V_{REF}, I_{KA}=10mA$ $T_{min} \leq T_A \leq T_{max}$		4.5	17	mV
Ratio of change in reference Input voltage to the change in cathode voltage	$\Delta V_{ref}/\Delta V_{KA}$	$I_{KA}=10mA$	$\Delta V_{KA}=10V \sim V_{REF}$	-1.0	-2.7	mV/V
			$\Delta V_{KA}=36V \sim 10V$	-0.5	-2.0	mV/V
Reference input current	I_{ref}	$I_{KA}=10mA, R_1=10k\Omega$ $R_2=\infty$		1.5	4	μA
Deviation of reference input current over full temperature range	$\Delta I_{ref}/\Delta T$	$I_{KA}=10mA, R_1=10k\Omega$ $R_2=\infty$ $T_A=full\ Temperature$		0.4	1.2	μA
Minimum cathode current for regulation	$I_{KA(min)}$	$V_{KA}=V_{REF}$		0.45	1.0	mA
Off-state cathode current	$I_{KA(OFF)}$	$V_{KA}=36V, V_{REF}=0$		0.05	1.0	μA
Dynamic impedance	Z_{KA}	$V_{KA}=V_{REF}, I_{KA}=1\ to\ 100mA$ $f \leq 1.0kHz$		0.15	0.5	Ω

Note: $T_{MIN}=0^{\circ}C, T_{MAX}=+70^{\circ}C$

CLASSIFICATION of V_{ref}

Rank	0.5%	1%
Range	2.487-2.513	2.475-2.525

RATINGS AND CHARACTERISTIC CURVES

■ Typical Characteristics

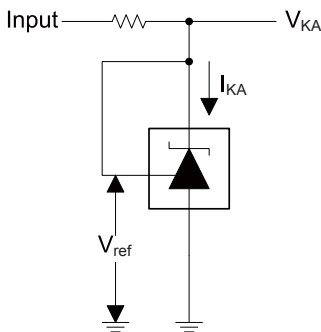
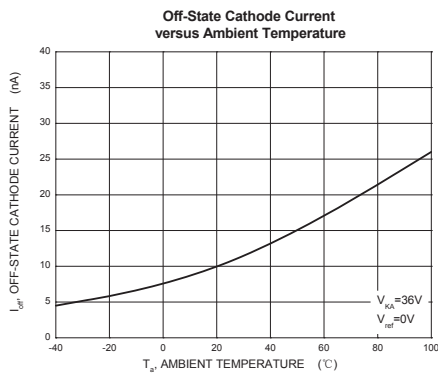
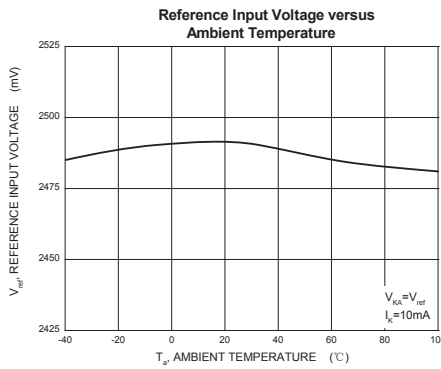
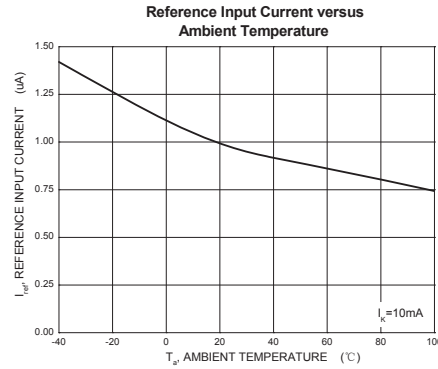
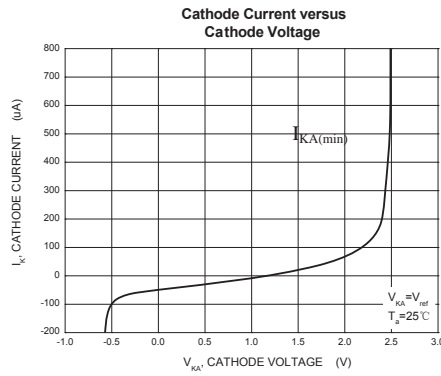
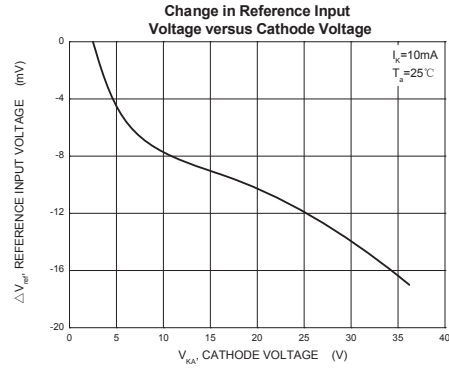
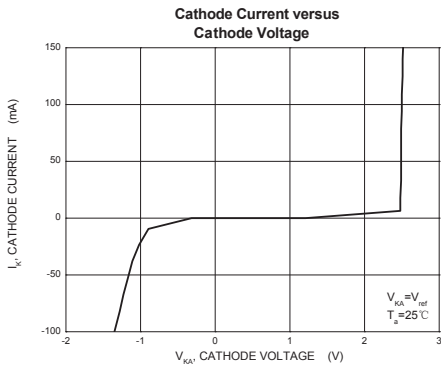

Test Circuit for $V_{KA} = V_{ref}$

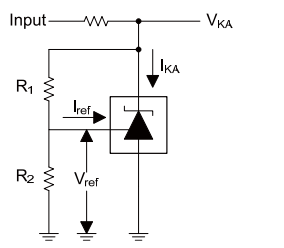

Test Circuit for $V_{KA} = V_{ref}(1+R1/R2)+R1 \cdot I_{ref}$

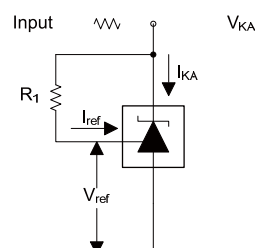

Test Circuit for I_{ref}

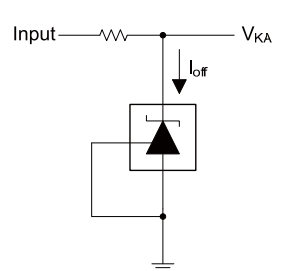

Test Circuit for I_{off}